

REDUCEERVENTIELEN BS-GL 50-1-2



- Lagedruk reduceerventiel - Enkeltraps
- Montage op cilinder
- Geschikt voor vloeibare zuivere gassen, niet corrosief in de gasfase
- In verchromd messing

Labo & Analyse

Toepassingsgebieden

Ontworpen voor implementatie van:
Zuivere vloeibare gassen in gasfase

Specificaties

Maximale ingangsdruk bij 15°C 50 bar
Uitgangsdruk 0,05 tot 1 bar
Nominaal debiet in N₂ 2 Nm³/h*

Materialen

Lichaam Verchromd messing
Balg: Brons

Dimensies:

Nettogewicht : 0.9 kg

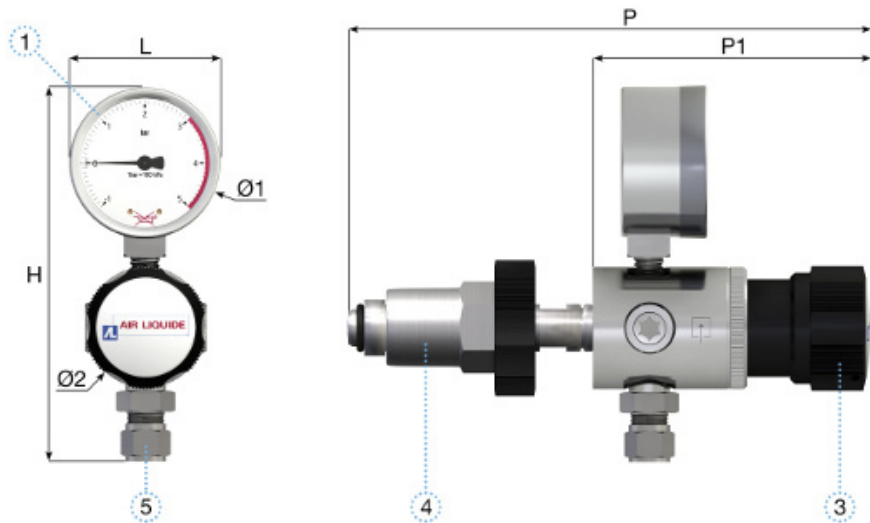

Handleiding:

OP 150 - BS-GL

Aansluiting

Ingangskoppeling: Hogedruk koppeling volgens het gas

Uitgangskoppeling: 2 uitgangen G 3/8" BSPP vrouwelijk





Bestelinformatie:

De reduceerventielen worden geleverd met een hogedruk koppeling volgens het gas en één of meerdere uitgangskoppelingen. Zij zijn uitgerust met een lagedruk manometer.



Producten:

Referentie	Korte beschrijving:	Gas	Ingangsdruk	Uitgangsdruk	Debiet	Ingangskoppeling:	Vorm van de ingangskoppeling:	Uitgangskoppeling:	Materiaal
15893	REG BS-GL 50-1-2 TYPE C/B4 - KIT N°2	Andere inerte mengsels	50 bar	1 bar	2 Nm³/h	Type C/B4	Handmoer verchroomd messing	KIT N°2	Messing
15896	REG BS-GL 50-1-2 MANO TYP C/B4 - KIT N°2	Andere inerte mengsels	50 bar	1 bar	2 Nm³/h	Type C/B4		KIT N°2	Messing

Options

	Referentie	Long designation
	16516	OLIVE SOEPELE BUIS INT.D4-6MM
	16521	KOPP.G3/8BUIT./DB 1/8"MESSING VERCHROOMD
	16522	KOPP.G3/8M/DB 6 VERCHR MESS.
	16523	GYROLOK RACCORD 3/8" - 1/4" LC
	16524	KOPP.G3/8"BUIT./DB10 MESSING VERCHROOMD

	Referentie	Long designation
	16526	KOPP.G3/8"BUIT./DB8MM MESSING VERCHROOMD
	16532	AUSGANG KIT N°2-GYROLOK
	16558	KOPP. G3/8" BUIT. / DB 6MM RVS
	16562	KOPP. G 3/8" BUIT DB 8 MM RVS
	16564	KOPP.G3/8" BUIT. / DB 3/8" RVS

	Referentie	Long designation
	16565	KOPP. G3/8" BUIT/ DB 1/4" RVS
	16566	KOPP. G3/8" BUIT. / DB 1/8" RVS
	16567	KOPP. G3/8" BUIT. / DB 10MM RVS

	Referentie	Long designation
	16569	KOPP.G3/8" BUIT. / DB 12 MM RVS
	19286	Koppeling Filete G3/8"-Crant-9MM

Spare parts

Referentie	Referentie wisselstuk	Long designation
15893	16005	PRESSURE GAUGE 0- 100 Bar Ø 50mm - Lateral Entry
	17141	FLAT SEAL in PTFE 14,5x10x2 for outlet port G3/8